

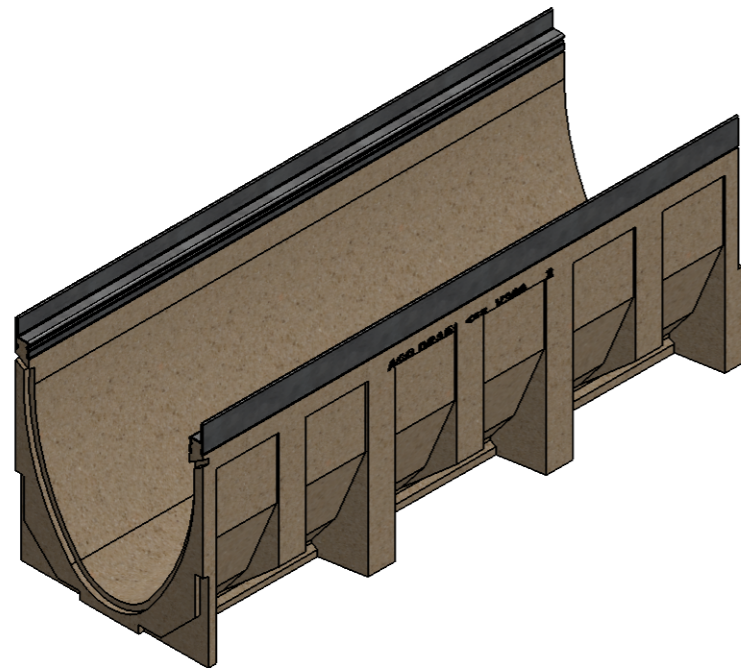

Masstab 1: 4

Masstab 1: 5

0.5% Sohlgefälle

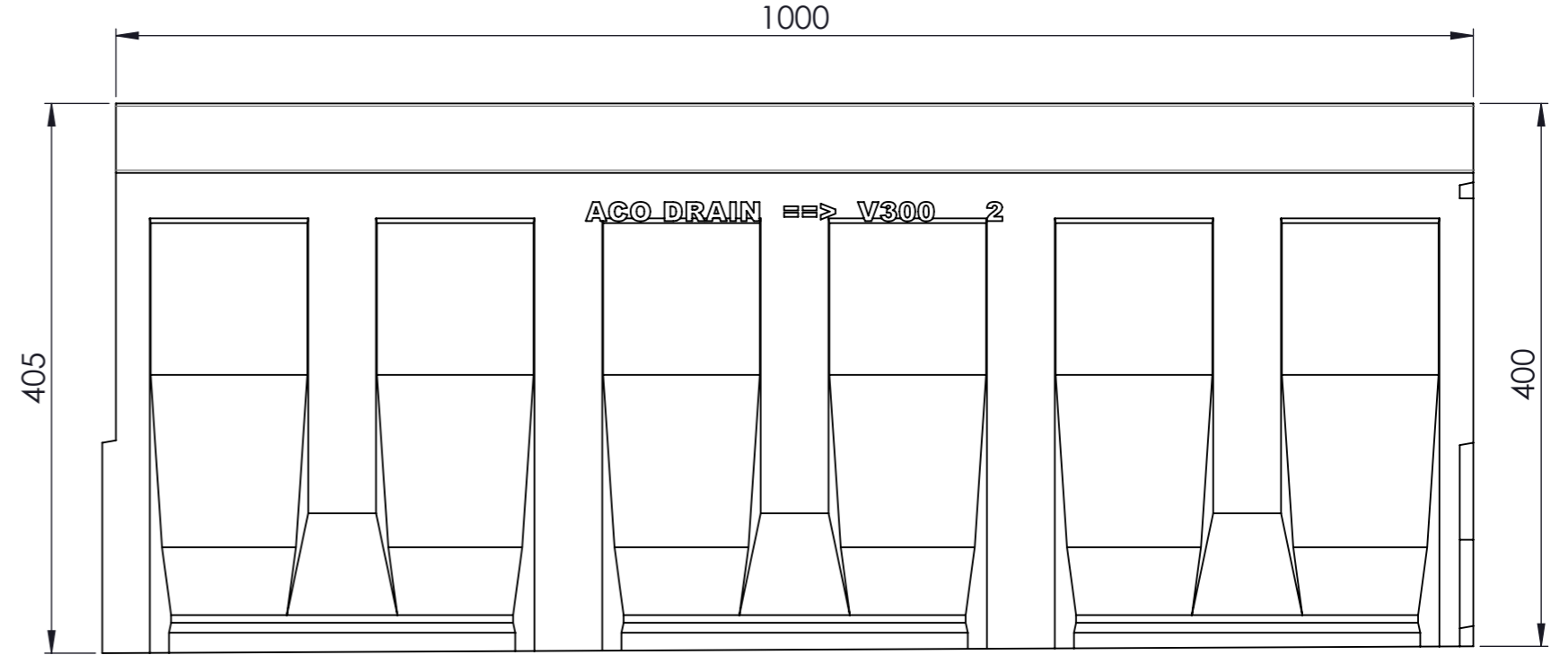
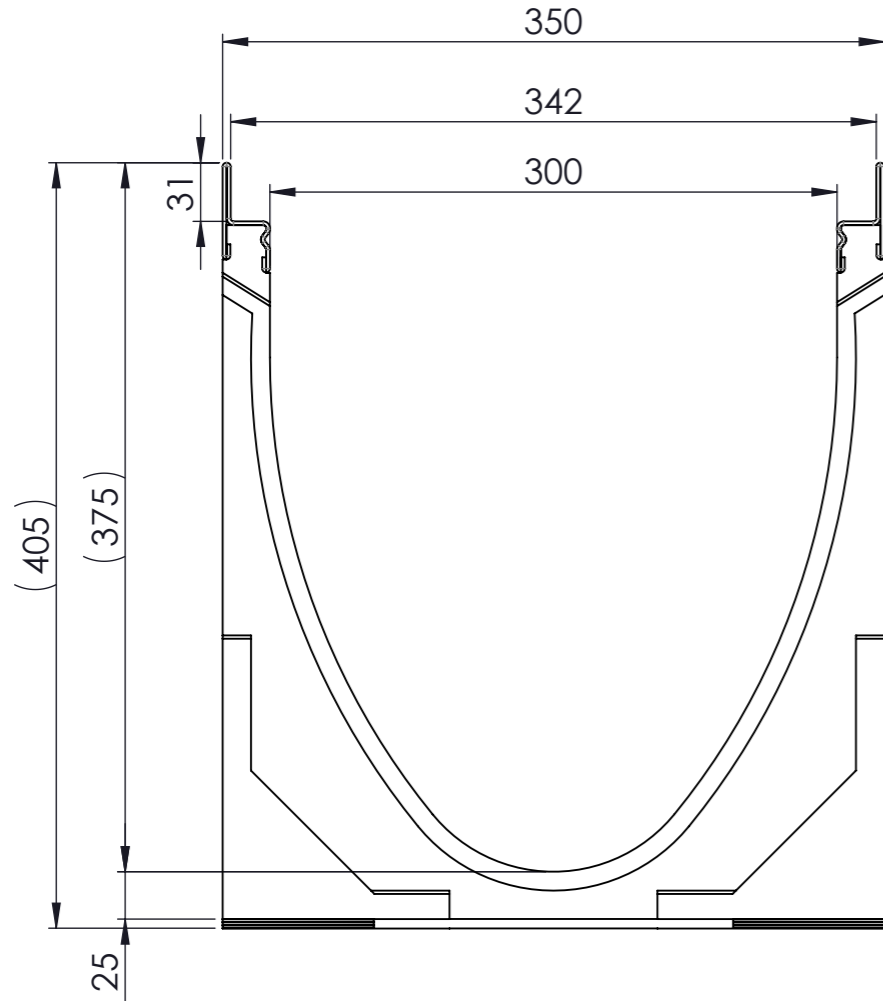

-mit Stahzarge
-Allgemeintoleranzen ISO 2768-m

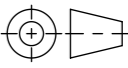
Werkstoff: Polymerbeton		Gewicht: 65.7 kg kg		 www.aco.ch	ACO Passavant AG Industrie Kleinzaun CH-8754 Netstal Tel. 055 / 645 53 00 - Fax 055 / 645 53 10 E-Mail: aco@aco.ch		
zul. Abweichung: Norm		Oberfläche: DIN ISO 1302			Diese Zeichnung darf weder kopiert noch dritten Personen, insbesondere zum Zweck anderweitiger Benutzung mitgeteilt werden und bleibt unser Eigentum. Copyright reserved! © ACO Passavant AG		
Erstellt:	Datum: 22.10.17	Name: haljilji	Masstab: 1:4	Masseinheit: Millimeter	Projektion: ISO-E		
Freigegeben:	19.06.2018	dca		Blatt / Anz.: 1 / 1			
Status:	Freigegeben						
Bauelemente Multiline V300 mit Sohlgefälle Typ 4 Art. Nr.: 13504				Zeichnung Nr.: CH 13504		Index: A	
A		04.06.2018	dca	Art.-Nr. angepasst			