

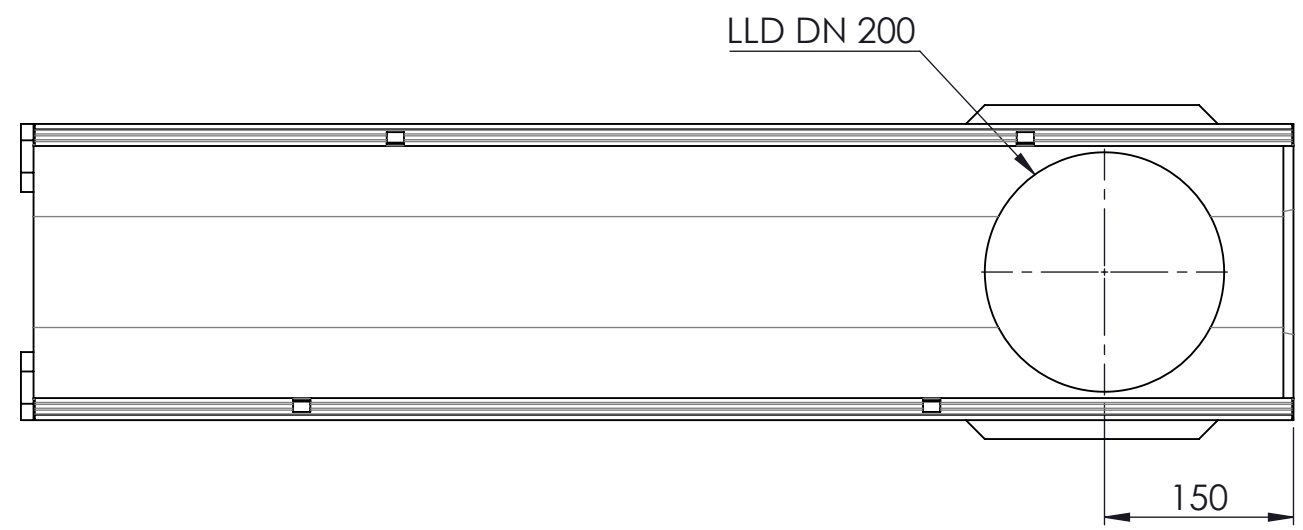

Masstab 1:2

Masstab 1:5

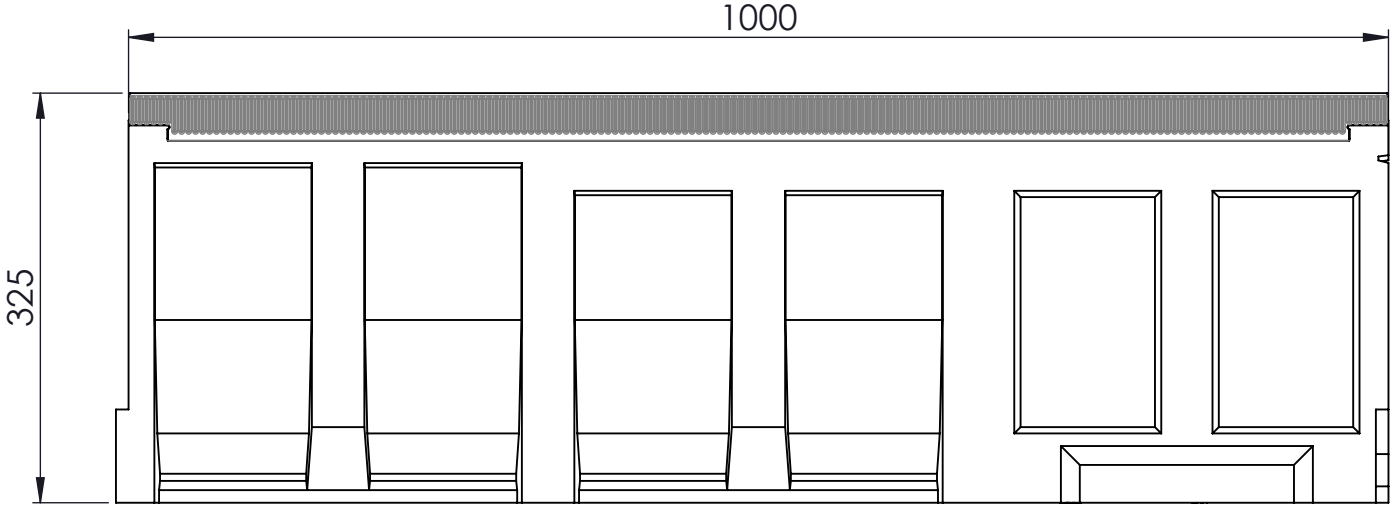
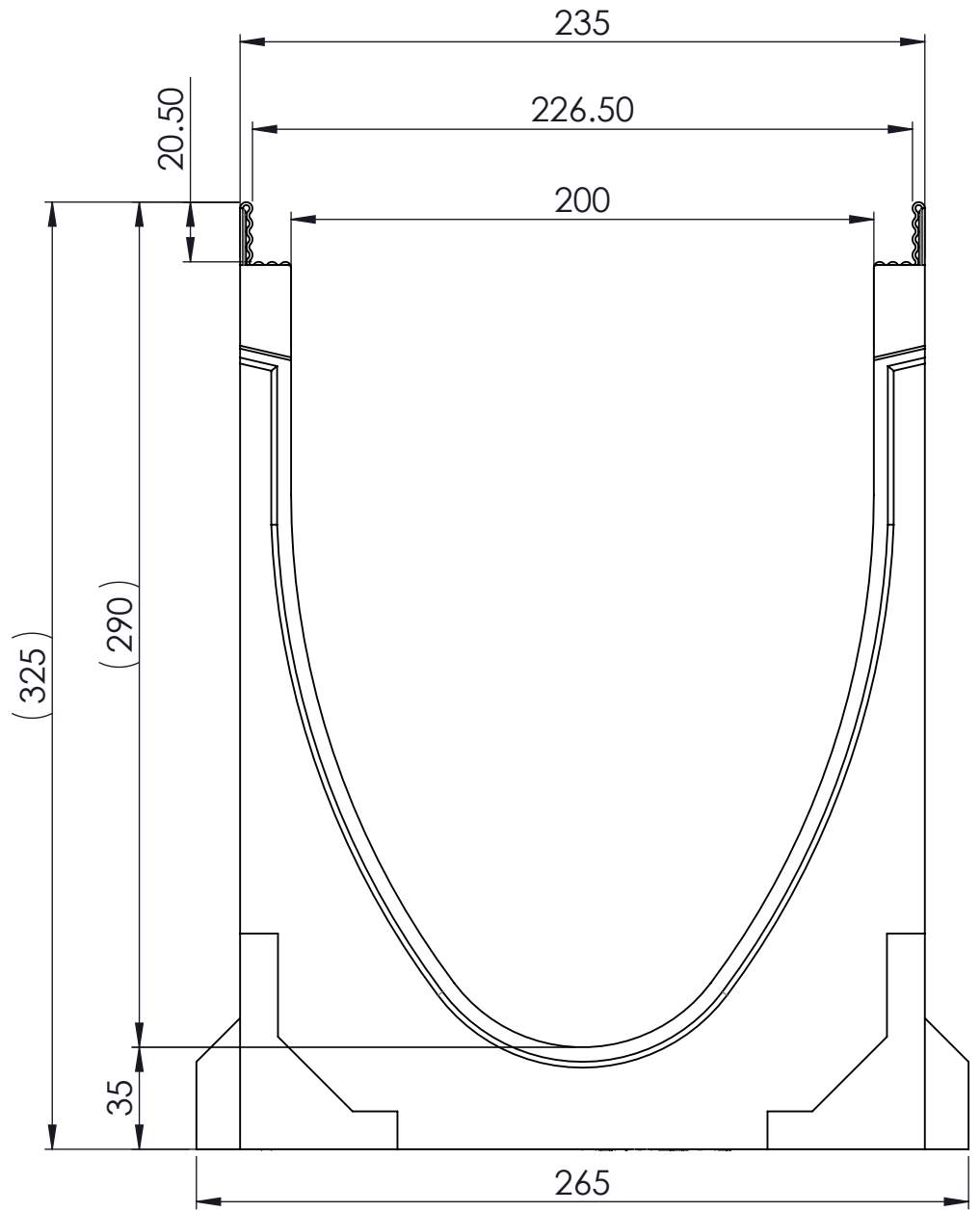
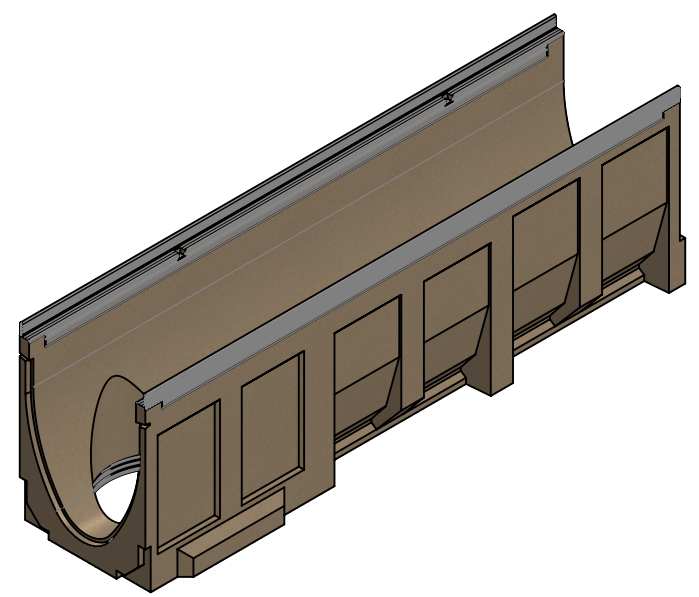

- mit verzinkter Stahlzarge (Hyper Steel)
- Allgemeintoleranzen ISO 2768-m

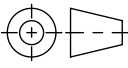

Werkstoff: <b>Polymerbeton</b>		Gewicht: <b>48.77 kg</b>		 <a href="http://www.aco.ch">www.aco.ch</a>	<b>ACO AG</b> Industrie Kleinzaun CH-8754 Netstal Tel. 055 / 645 53 00 E-Mail: <a href="mailto:aco@aco.ch">aco@aco.ch</a>		 Diese Zeichnung darf weder kopiert noch dritten Personen, insbesondere zum Zweck anderweitiger Benutzung mitgeteilt werden und bleibt unser Eigentum. Copyright reserved! © ACO AG
zul. Abweichung: <b>Norm</b>		Oberfläche: <b>DIN ISO 1302</b>					
	Datum:	Name:	Masstab:	Masseinheit:	Projektion: ISO-E		
Erstellt:	18.09.17	halijli	<b>1:2</b>	Millimeter			
Freigegeben:	06.09.2024	Hans		Blatt / Anz.:		1 / 1	
Status:	Freigegeben						
Bauelemente <b>Multiline V200 S Typ 10.0.2</b> für senkrechten Anschluss Art. Nr.: 2003040				Zeichnung Nr.:		Index:	
				<b>CH 13151</b>		<b>C</b>	
C	15.08.2024	dca	SAP-Nr.				
B	20.12.2023	nae	Zarge				

Plottedatum: 06.09.2024