

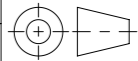

Werkstoff: 1.4404 / EPDM		Gewicht: 0.93 kg		 www.aco.ch	ACO AG Industrie Kleinzaun CH-8754 Netstal Tel. 055 / 645 53 00 E-Mail: aco@aco.ch			
zul. Abweichung: Norm		Oberfläche: DIN ISO 1302			Diese Zeichnung darf weder kopiert noch dritten Personen, insbesondere zum Zweck anderweitiger Benutzung mitgeteilt werden und bleibt unser Eigentum. Copyright reserved! © ACO AG			
Erstellt:	Datum: 19.09.2023	Name: bae	Massstab: 1:2	Masseinheit: Millimeter	Projektion: ISO-E			
Freigegeben:	15.09.2024	Hans		Blatt / Anz.: 1 / 1				
Status:	Freigegeben							
Haustechnik Pipe Abzweig reduziert 45° DN100/70 Pipe Formstücke, Abzweig reduziert 45° Art. Nr.: 2014164				Zeichnung Nr.: CH 400671		Index: A		
A		12.09.2024		Hans		SAP-Nr.		
-						Erstausgabe		