

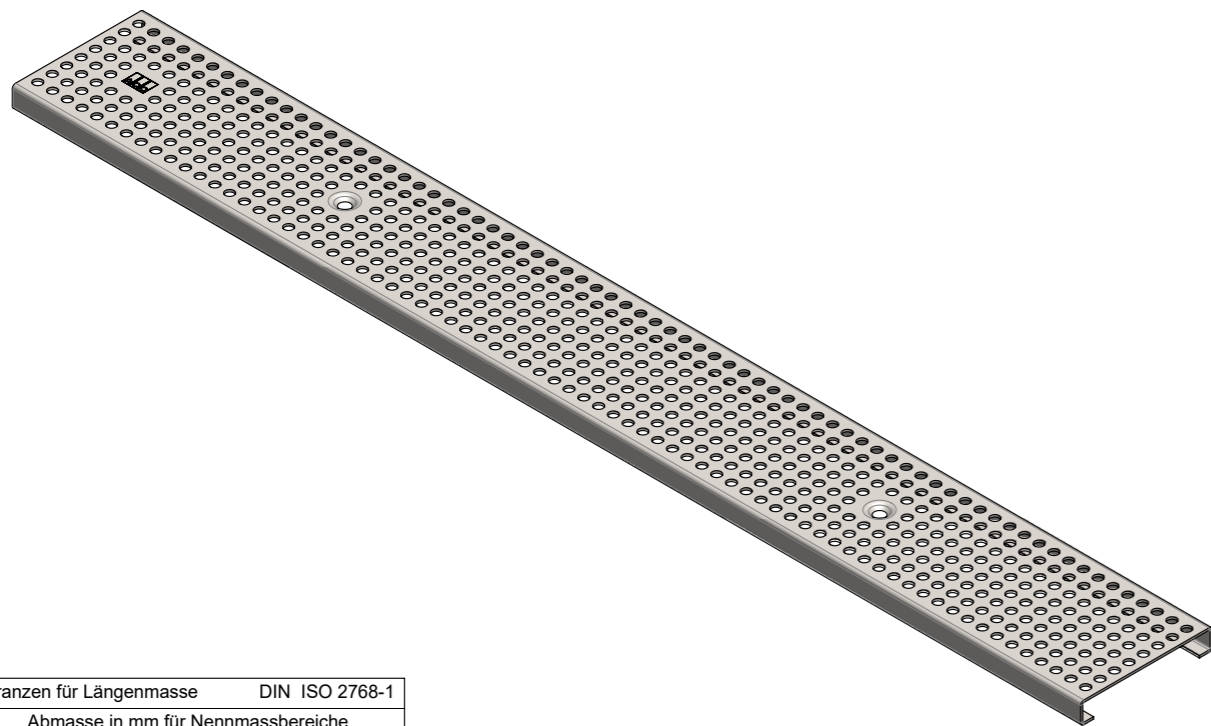

A-A (1:1)

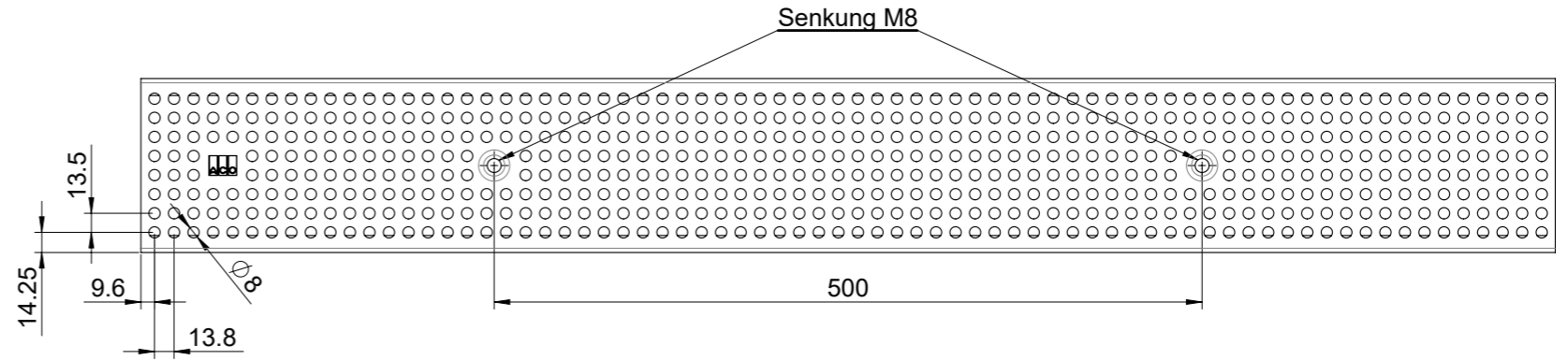
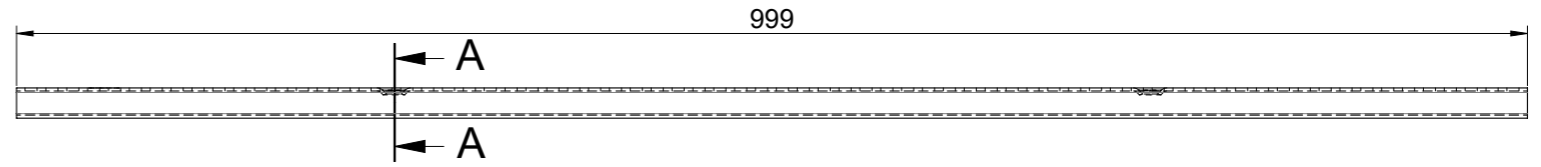
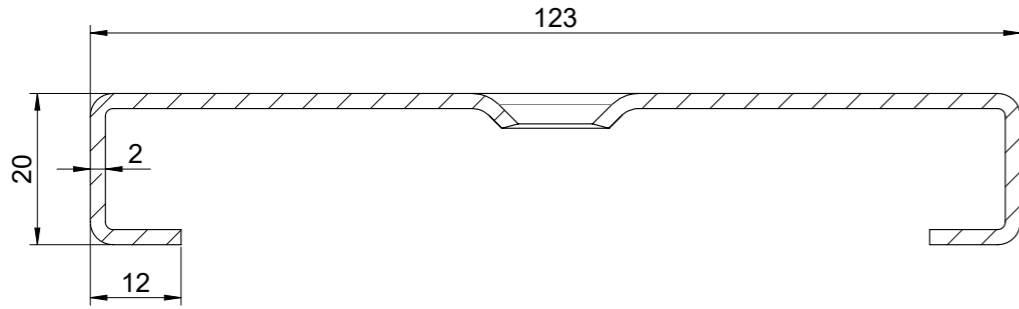

Allgemeintoleranzen für Längenmasse		DIN ISO 2768-1					
Genauigkeitsgrad		Abmasse in mm für Nennmassbereiche					
	0,5 ... 3	> 3 ... 6	> 6 ... 30	> 30 ... 120	> 120 ... 400	> 400 ... 1000	> 1000 ... 2000
m (mittel)	± 0.1	± 0.1	± 0.2	± 0.3	± 0.5	± 0.8	± 1.2

Werkstoff: 1.4301 (X5CrNi18-10)		Gewicht: 2.32 kg		 www.aco.ch	ACO AG Industrie Kleinzaun CH-8754 Netstal Tel. 055 / 645 53 00 E-Mail: aco@aco.ch		
zul. Abweichung: Norm		Oberfläche: DIN ISO 1302			Diese Zeichnung darf weder kopiert noch dritten Personen, insbesondere zum Zweck anderweitiger Benutzung mitgeteilt werden und bleibt unser Eigentum. Copyright reserved! © ACO AG		
Erstellt:	Datum: 07.09.2022	Name: AB	Massstab: 1:5	Masseinheit: Millimeter	Projektion: ISO-E	Index: A	
Freigegeben:	17.08.2024	dca		Blatt / Anz.: 1 / 1			
Status:	Freigegeben						
Haustechnik Lochrost A15, arretierbar, Loch-Ø8.0 Art. Nr.: 2090496				Zeichnung Nr.: CH 420054			
				A	16.08.2024	dca	SAP-Nr.
				-			Erstausgabe

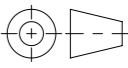
Plattdatum: 17.08.2024