

Einlauf (180°): DN300 - Ø315
Rohrmat.: PE-HD

Auslauf (0°): DN300 - Ø315
Rohrmat.: PE-HD

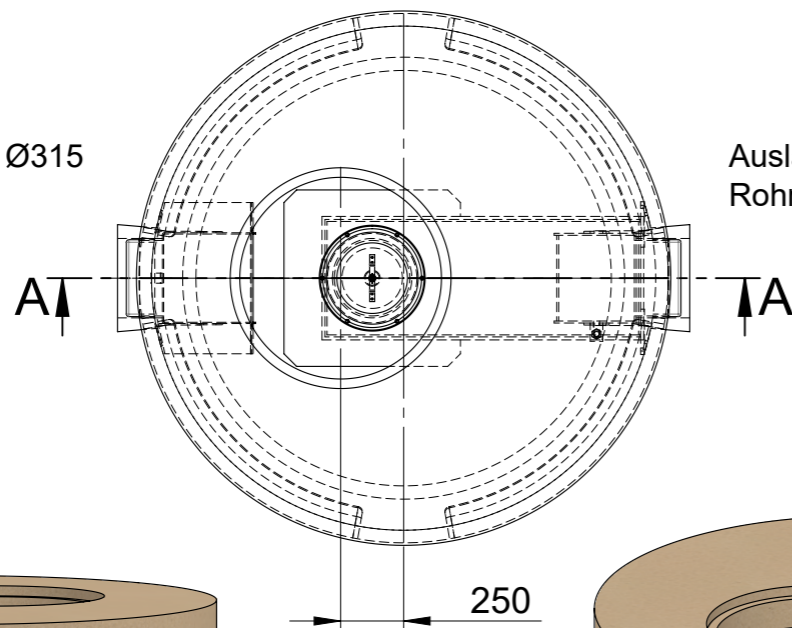

Ölspeichervolumen = 760 Liter

Gesamtgewicht: 1950kg

Kontrollexemplar

Datum : _____

Stempel / Signum : _____

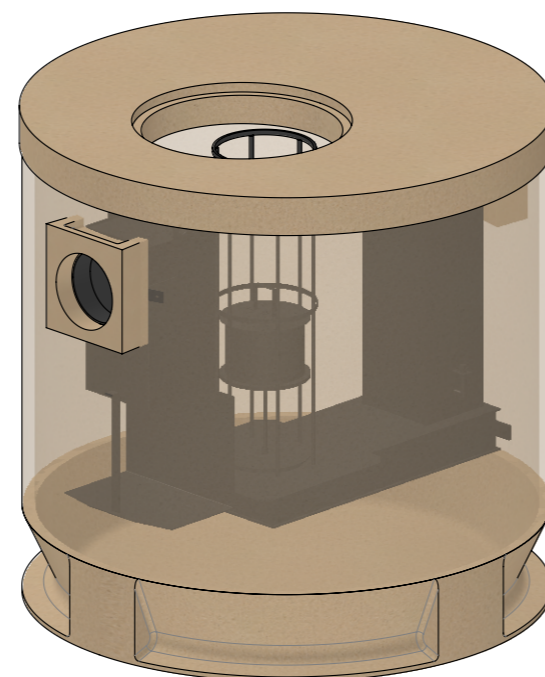
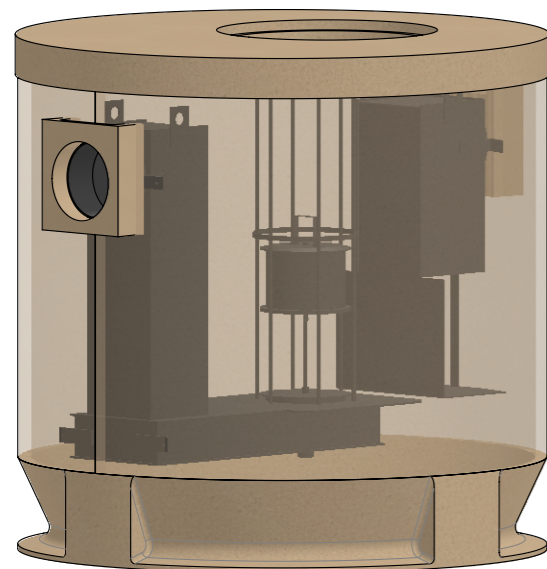

Werkstoff:		Gewicht: 3351.28 kg		 www.aco.ch	ACO AG Industrie Kleinzaun CH-8754 Netstal Tel. 055 / 645 53 00 E-Mail: aco@aco.ch	
zul. Abweichung: Norm		Oberfläche: DIN ISO 1302				
Erstellt:	Datum: 12.11.2020	Name: KJ	Massstab: 1:30	Masseinheit: Millimeter	Projektion: ISO-E	Diese Zeichnung darf weder kopiert noch dritten Personen, insbesondere zum Zweck anderweitiger Benutzung mitgeteilt werden und bleibt unser Eigentum. Copyright reserved! © ACO AG
Freigegeben:	07.09.2024	dca		Blatt / Anz.: 1 / 1		
Status:	Freigegeben			Zeichnung Nr.: CH 444088		
Bauelemente Polycom Typ 2 NS 50 Klasse 1 - NG 50 l/s Art. Nr.: 2092064				SAP Nr.: Erstaussgabe		