

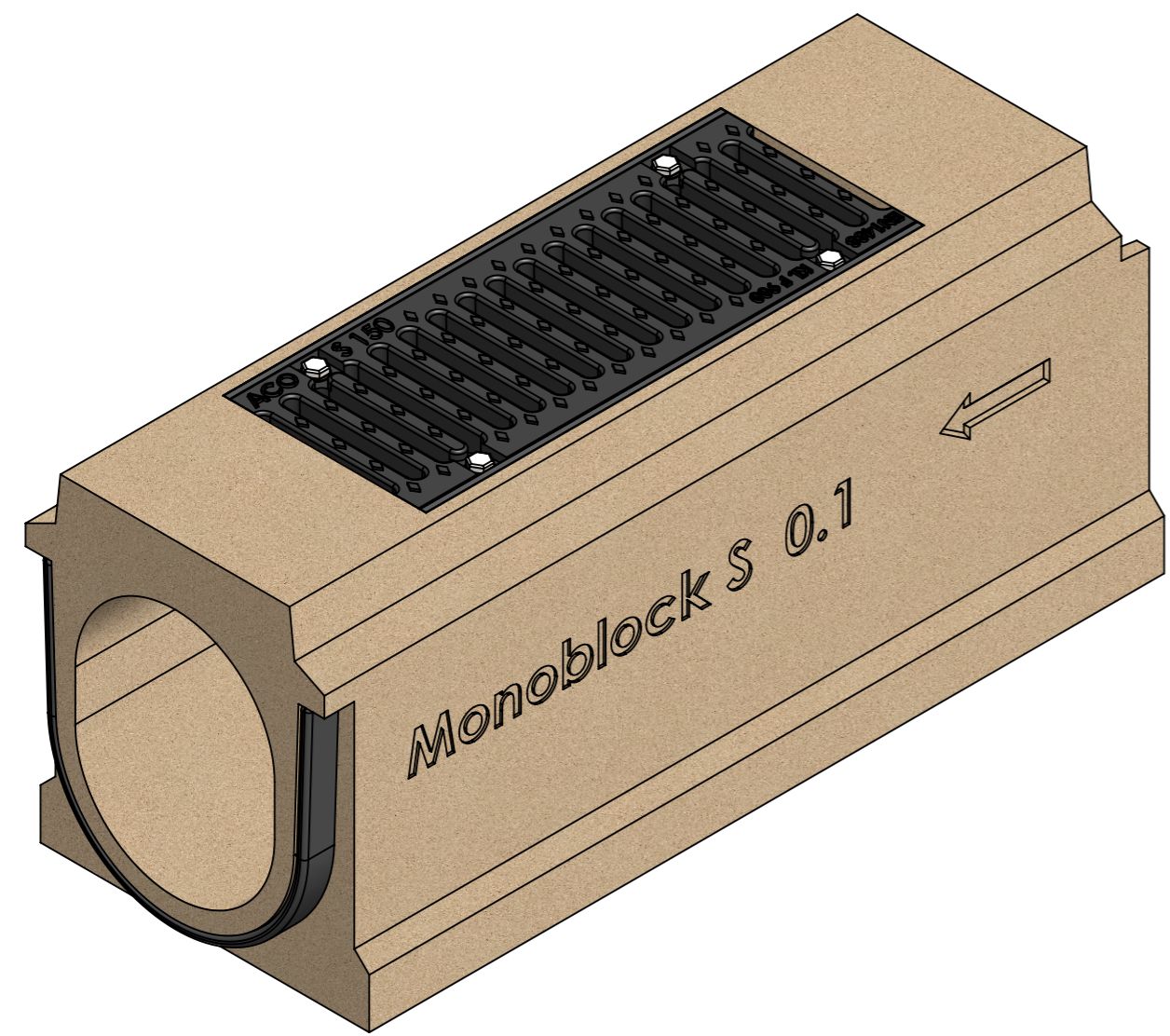

1 2 3 4 5 6 7 8

A  
B  
C  
D  
E  
F

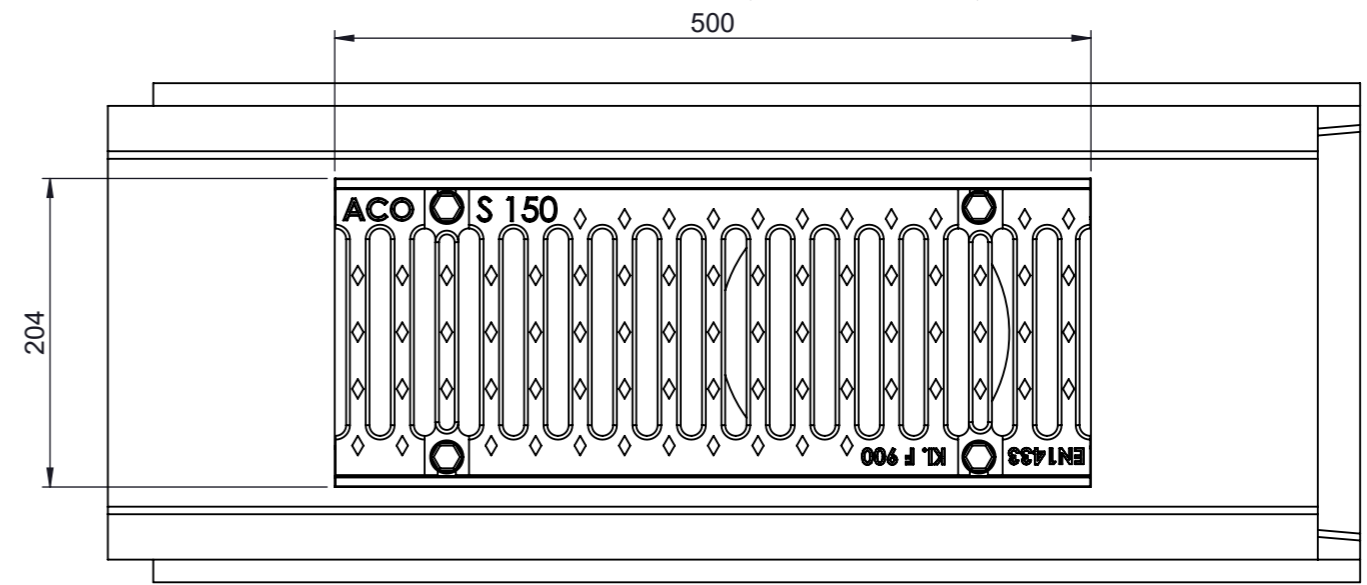
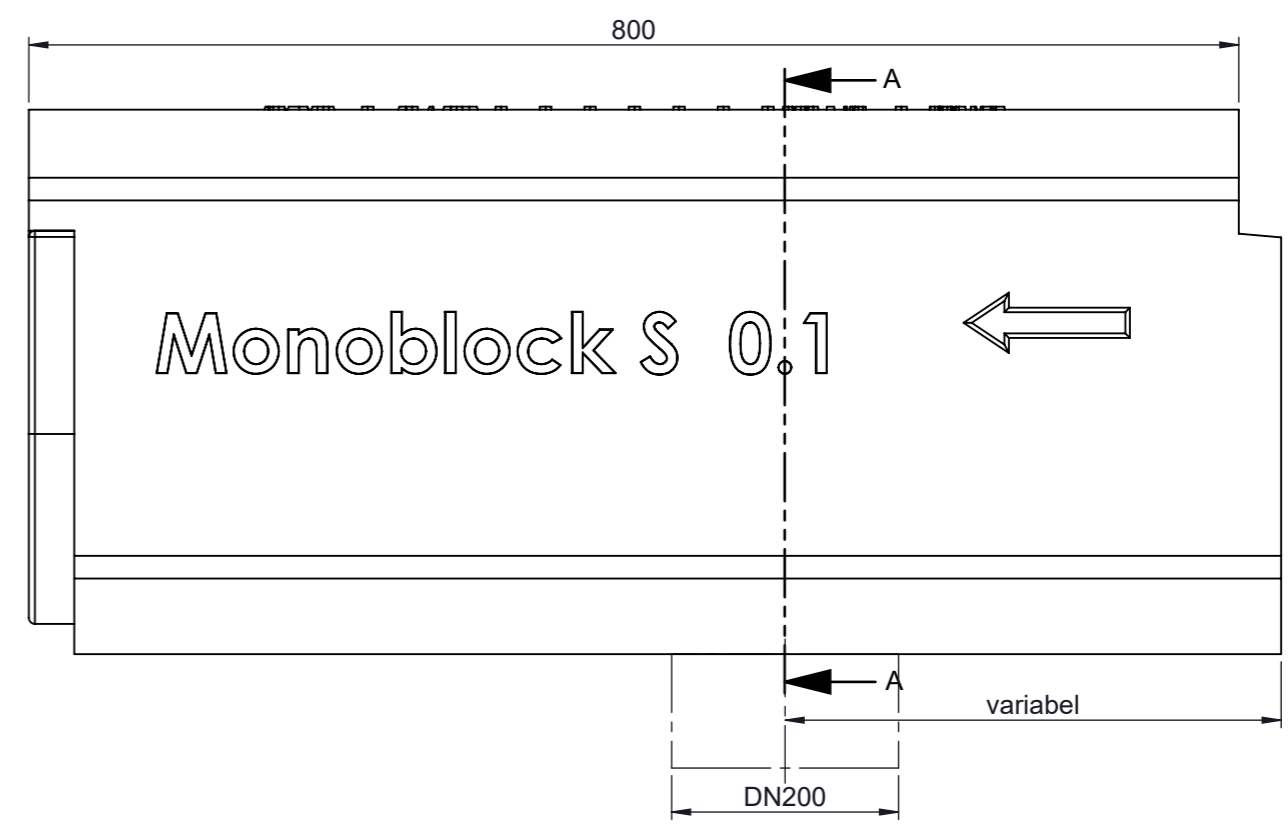
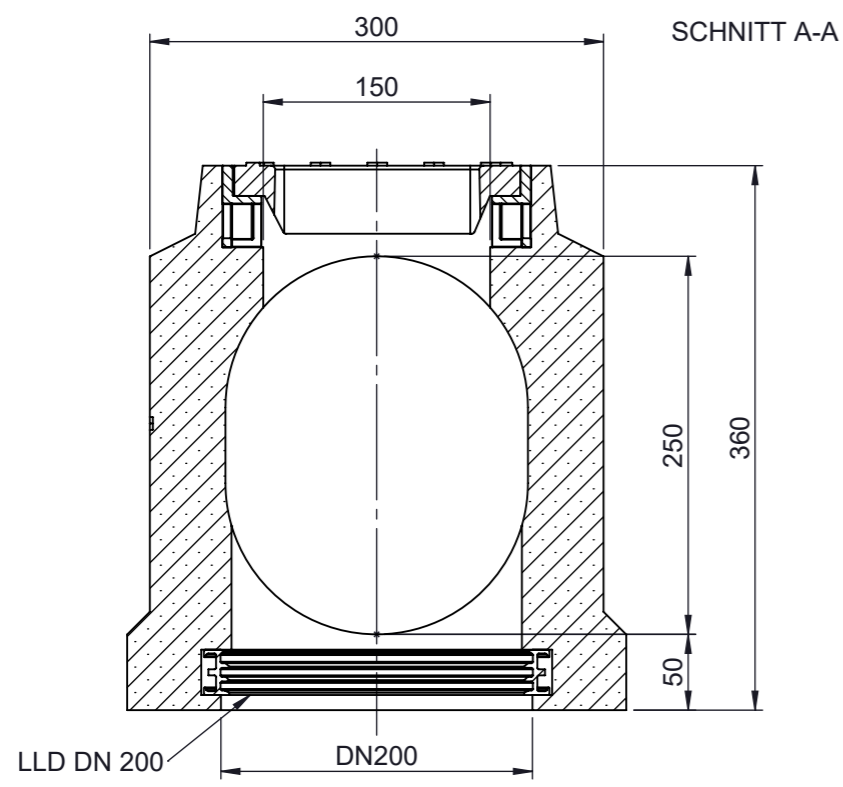

Werkstoff: <b>Polymerbeton</b>		Gewicht: <b>113.66 kg</b>		 www.aco.ch	<b>ACO Passavant AG</b> Industrie Kleinzaun CH-8754 Netstal Tel. 055 / 645 53 00 - Fax 055 / 645 53 10 E-Mail: aco@aco.ch			
zul. Abweichung: <b>Norm</b>		Oberfläche: <b>DIN ISO 1302</b>			Diese Zeichnung darf weder kopiert noch dritten Personen, insbesondere zum Zweck anderweitiger Benutzung mitgeteilt werden und bleibt unser Eigentum. Copyright reserved! © ACO Passavant AG			
Erstellt:	Datum: 24.01.2019	Name: AB	Masstab: <b>1:5</b>	Masseinheit: <b>Millimeter</b>	Projektion: ISO-E	Zeichnung Nr.: <b>CH 77295</b>		
Freigegeben:	24.01.2019	AB		Blatt / Anz.: 1 / 1				Index: <b>A</b>
Status:	Freigegeben							Benennung
Bauelemente <b>Revisionselement 800mm zu Monoblock S</b> mit Auslauföffnung senkrecht DN200, Belagsanschluss Art. Nr.: 77295								

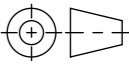
1 2 3 4 5 6 7 8