

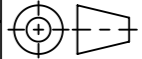

Werkstoff: Polymerbeton		Gewicht: 1.6 kg kg		 www.aco.ch	ACO Passavant AG Industrie Kleinzaun CH-8754 Netstal Tel. 055 / 645 53 00 - Fax 055 / 645 53 10 E-Mail: aco@aco.ch		
zul. Abweichung: Norm		Oberfläche: DIN ISO 1302			Diese Zeichnung darf weder kopiert noch dritten Personen, insbesondere zum Zweck anderweitiger Benutzung mitgeteilt werden und bleibt unser Eigentum. Copyright reserved! © ACO Passavant AG		
	Datum:	Name:	Massstab: 1:2	Masseinheit:	Projektion: ISO-E		
Erstellt:	23.02.18	halj		Millimeter			
Freigegeben:	19.06.2018	dca		Blatt / Anz.:	1 / 1		
Status:	Freigegeben						
Bauelemente Multiline V100 Zubehör Typ 10, mit LLD DN100 Art. Nr.: 12388				Zeichnung Nr.:		Index:	
				CH 12388		B	
		B	04.06.2018	dca	Art.-Nr. angepasst		
		A	24.04.2018	dca	anpassung		