

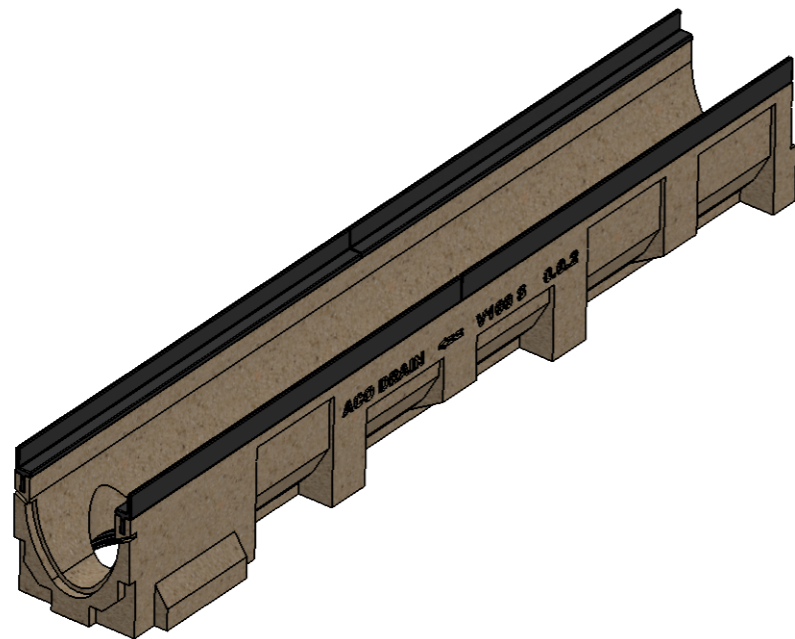

Masstab 1:2

Masstab 1:5

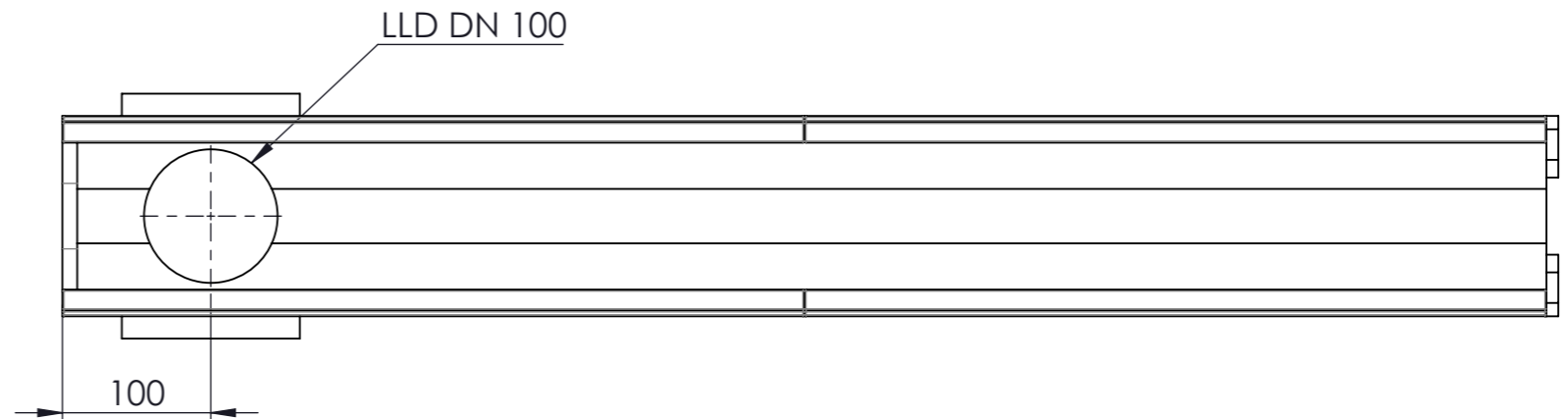
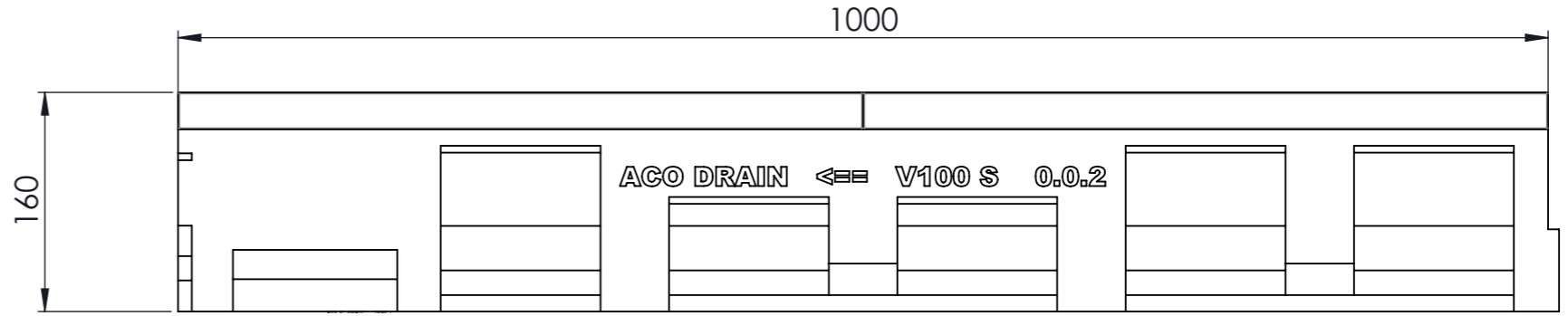
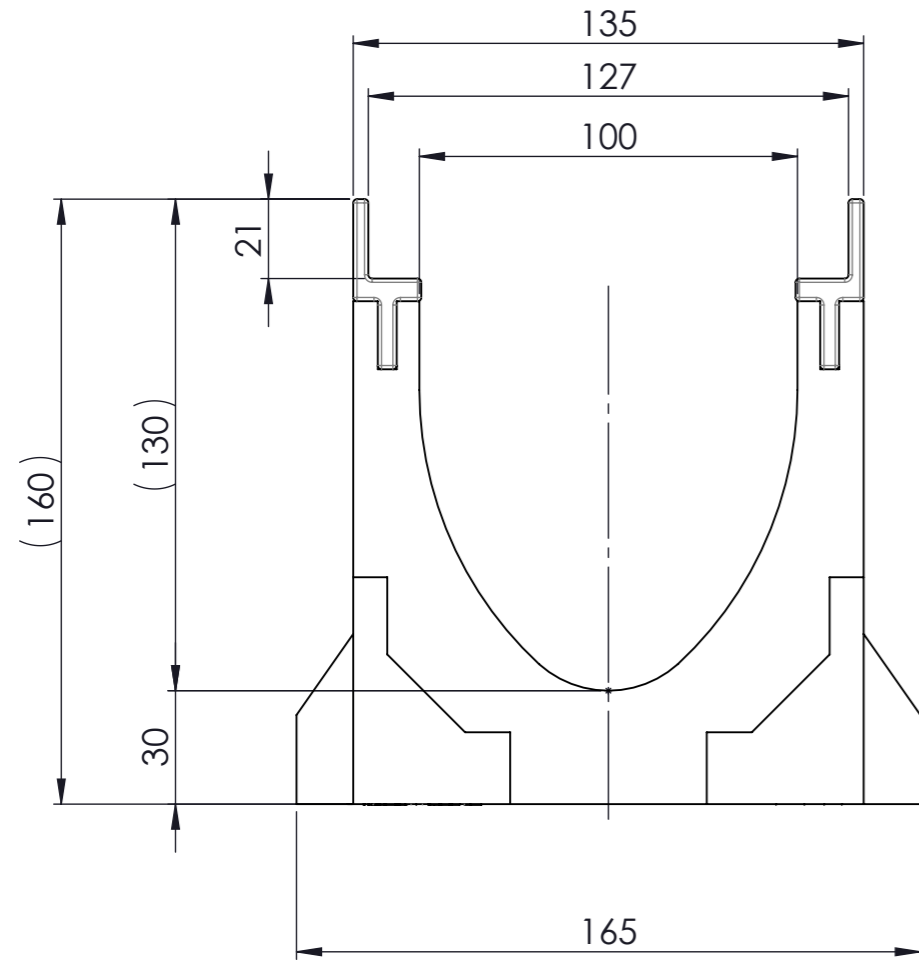

- mit Gusszargen
- Allgmeintoleranzen ISO 2768-m

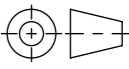
Werkstoff: Polymerbeton		Gewicht: 16.7kg kg		 www.aco.ch	ACO Passavant AG Industrie Kleinzaun CH-8754 Netstal Tel. 055 / 645 53 00 - Fax 055 / 645 53 10 E-Mail: aco@aco.ch			
zul. Abweichung: Norm		Oberfläche: DIN ISO 1302			Diese Zeichnung darf weder kopiert noch dritten Personen, insbesondere zum Zweck anderweitiger Benutzung mitgeteilt werden und bleibt unser Eigentum. Copyright reserved! © ACO Passavant AG			
Erstellt:	Datum: 14.08.17	Name: halijli	Masstab: 1:2	Masseinheit: Millimeter	Projektion: ISO-E			
Freigegeben:	19.06.2018	dca		Blatt / Anz.: 1 / 1				
Status:	Freigegeben							
Bauelemente Multiline V100 für senkr./seitl. Anschluss Typ 0.0.2 Art. Nr.: 12531				Zeichnung Nr.: CH 12531		Index: A		
A		04.06.2018	dca	Art.-Nr. angepasst				