

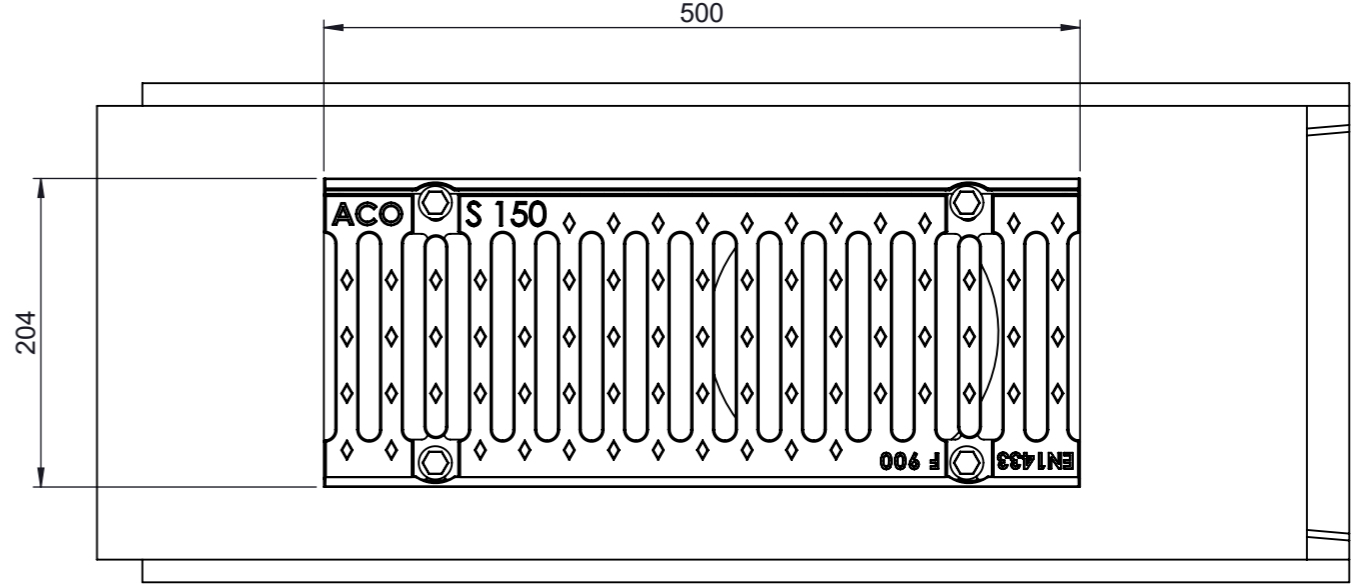

1 2 3 4 5 6 7 8

A
B
C
D
E
F

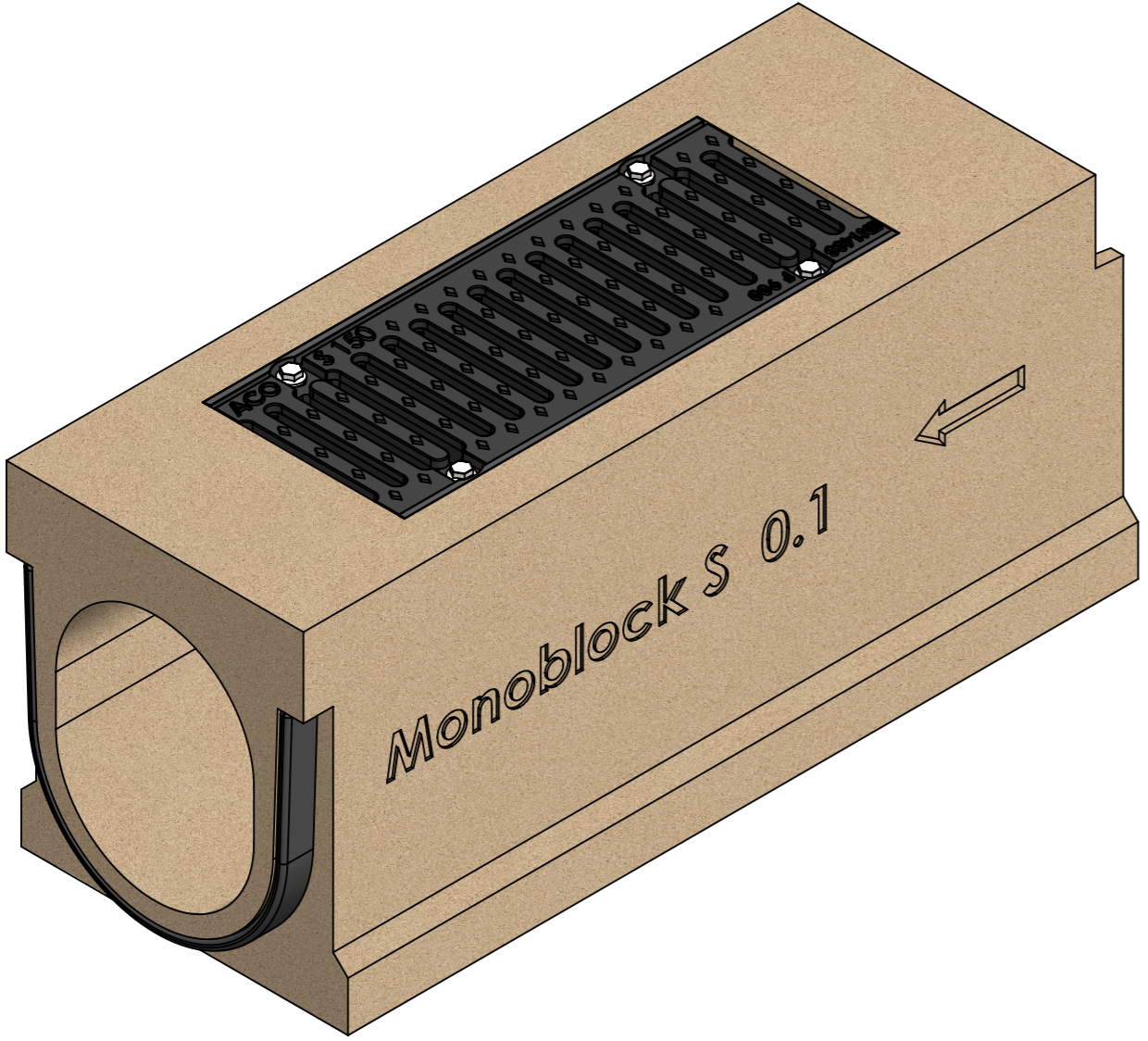
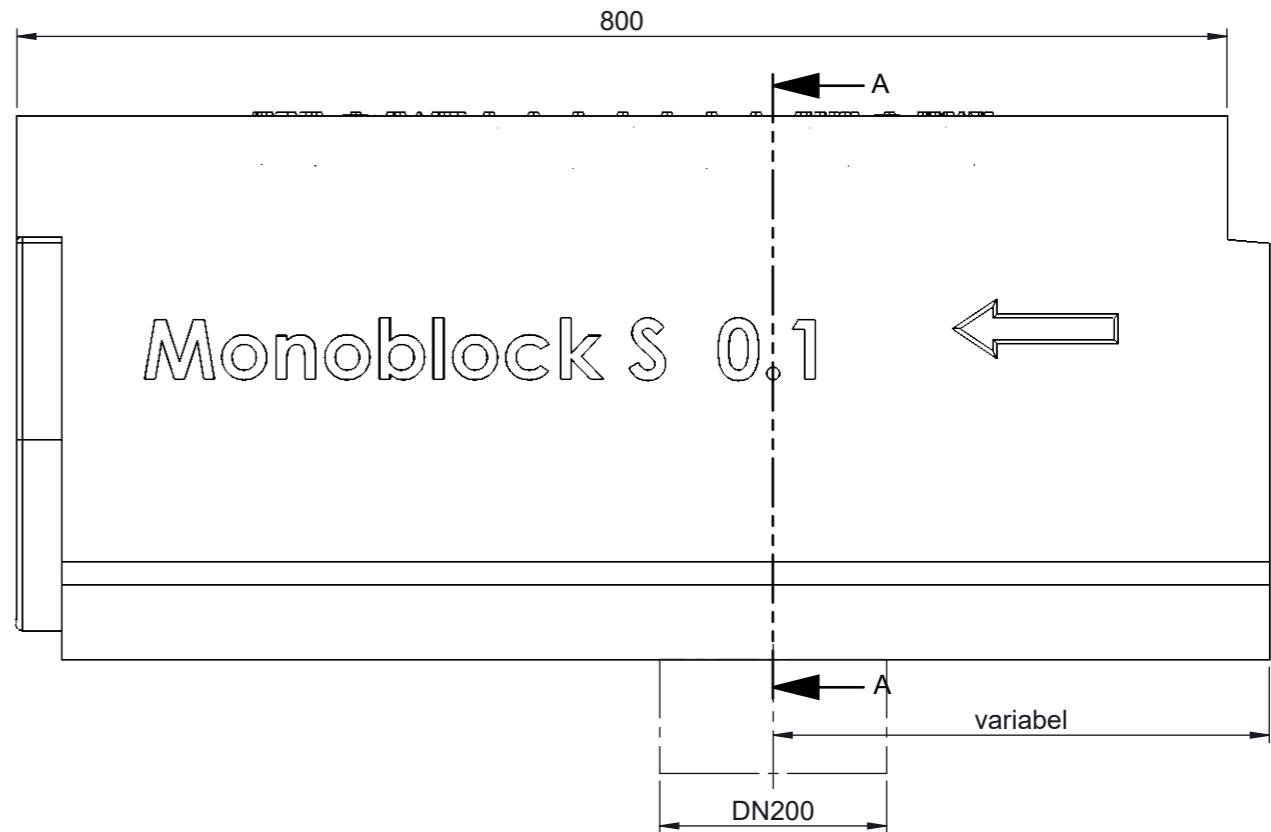
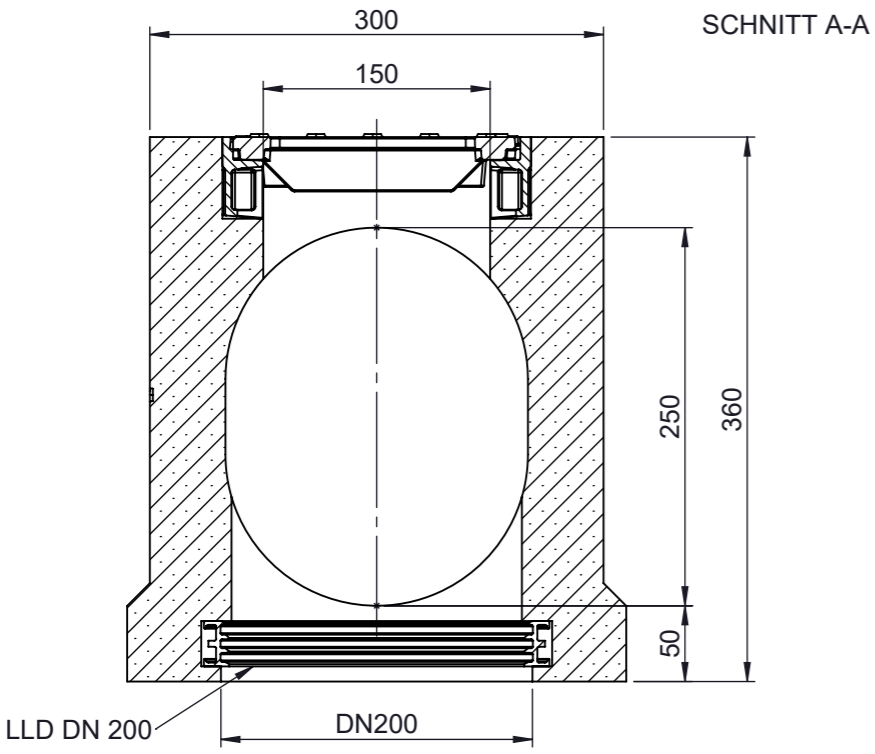

Werkstoff: Polymerbeton		Gewicht: 113.18 kg		 www.aco.ch	ACO AG Industrie Kleinzaun CH-8754 Netstal Tel. 055 / 645 53 00 E-Mail: aco@aco.ch		
zul. Abweichung: Norm		Oberfläche: DIN ISO 1302			Diese Zeichnung darf weder kopiert noch dritten Personen, insbesondere zum Zweck anderweitiger Benutzung mitgeteilt werden und bleibt unser Eigentum. Copyright reserved! © ACO AG		
Erstellt:	Datum: 10.09.2024	Name: dca	Masstab: 1:5	Masseinheit: Millimeter	Projektion: ISO-E	Index: A	
Freigegeben:	Status: Freigegeben		Blatt / Anz.: 1 / 1				
Baelemente Revisionselement 800mm zu Monoblock S Auslauföffnung senkrecht DN200, Betonanschluss Art. Nr.: 2086635			Zeichnung Nr.: CH 77262				

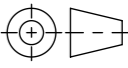
1 2 3 4 5 6 7 8 CAD-System: SolidWorks A3

Ploddatum: 11.09.2024