

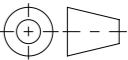

Werkstoff: 1.4301		Gewicht: 0.65 kg		 www.aco.ch	ACO AG Industrie Kleinzaun CH-8754 Netstal Tel. 055 / 645 53 00 E-Mail: aco@aco.ch		 Diese Zeichnung darf weder kopiert noch dritten Personen, insbesondere zum Zweck anderweitiger Benutzung mitgeteilt werden und bleibt unser Eigentum. Copyright reserved! © ACO AG
zul. Abweichung: Norm		Oberfläche: DIN ISO 1302			Projektion: ISO-E 		
Erstellt:	Datum: 03.10.2025	Name: bae	Massstab: 1:2	Masseinheit: Millimeter	Blatt / Anz.: 1 / 1		
Freigegeben:	06.10.2025	bae					
Status:	Freigegeben						
ACO-Standard Rostaufnahme DN70 123x123 H138 V2A				Zeichnung Nr.:		Index:	
Art. Nr.: 3008162				CH 3008162		-	
				Erstausgabe			