

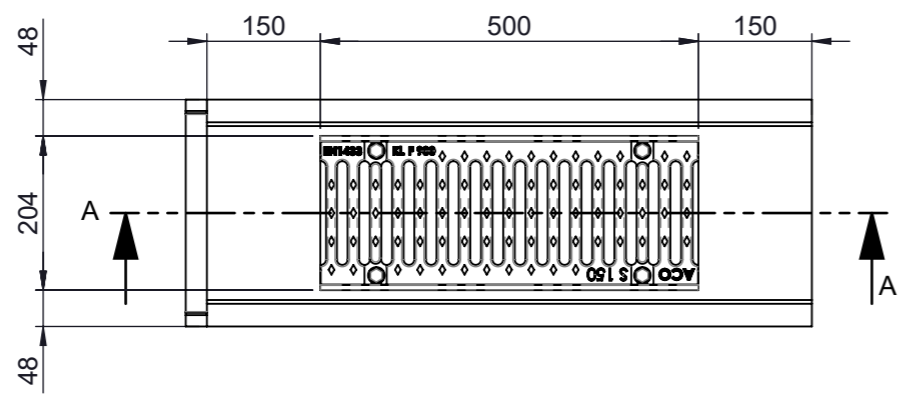

SCHNITT A-A
MAßSTAB 1 : 5

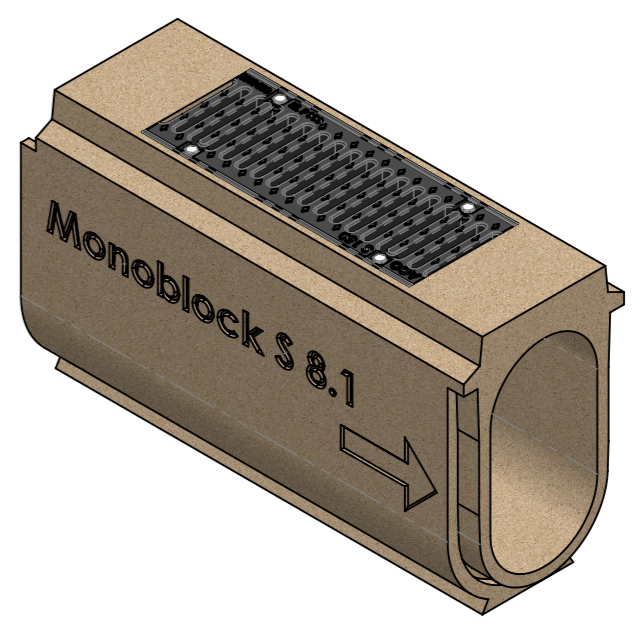
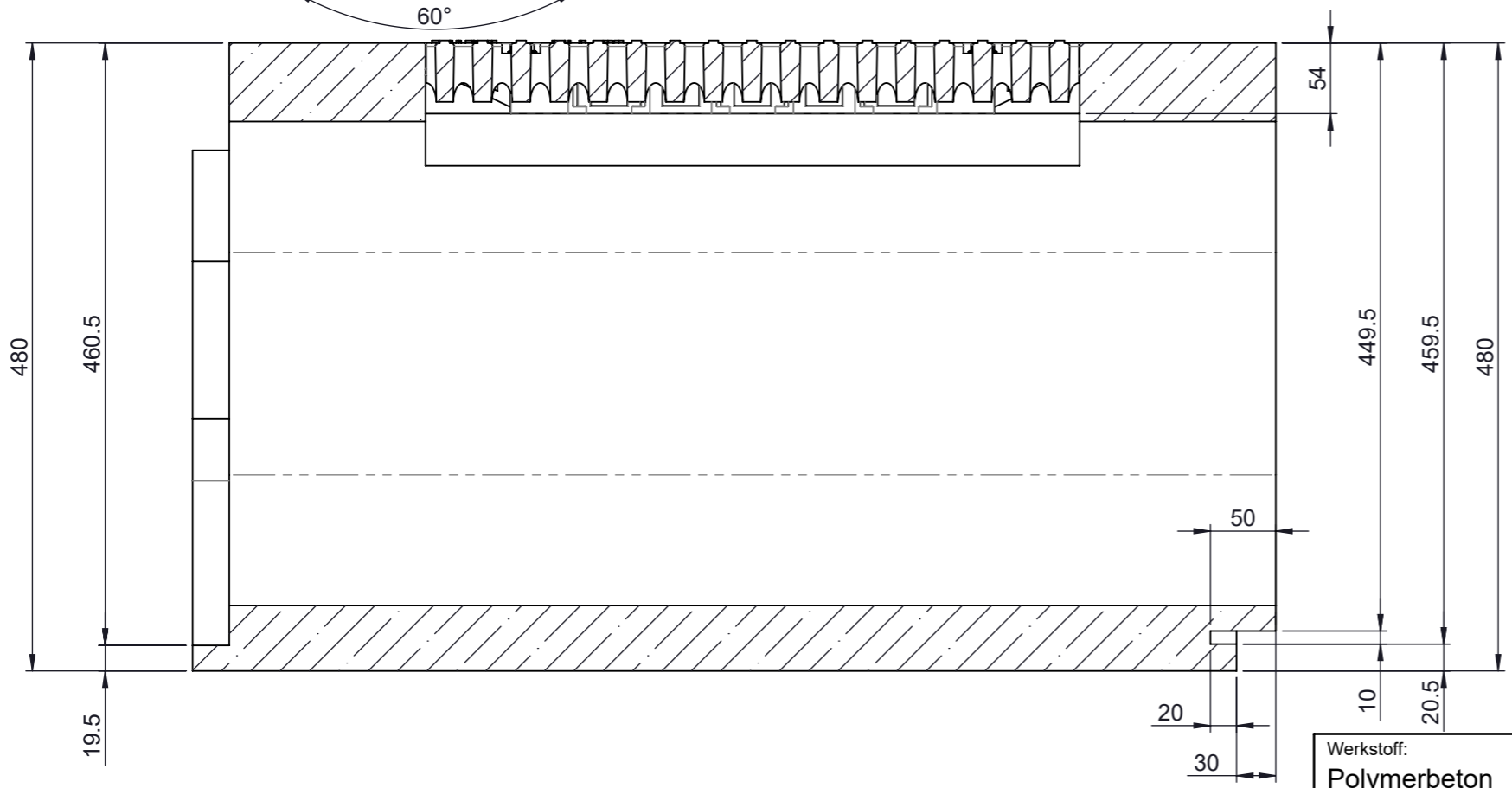
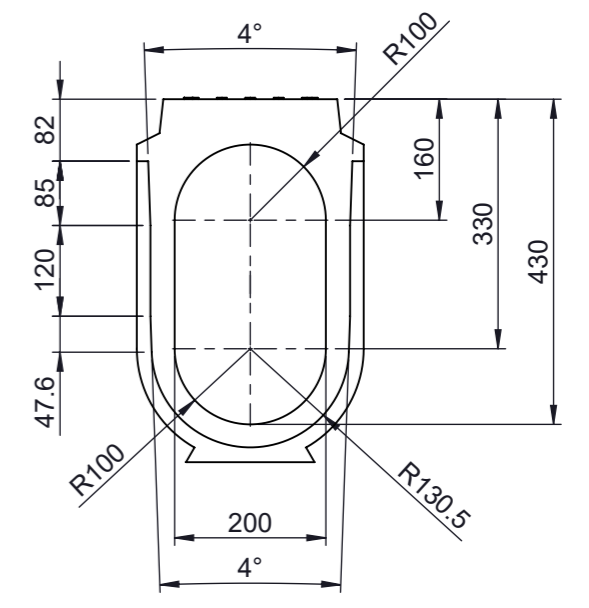
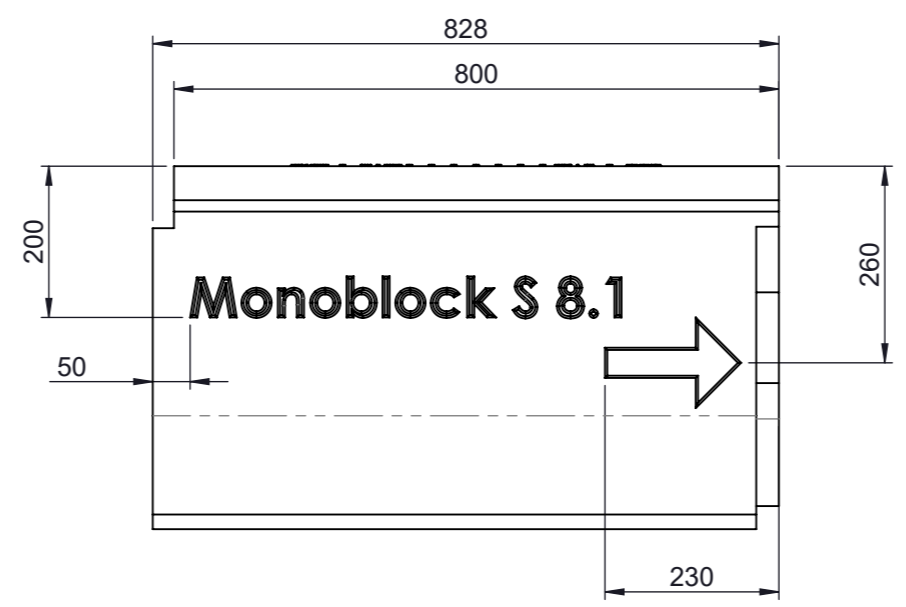
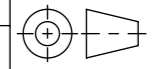

Werkstoff: Polymerbeton		Gewicht: 121.25 kg		 ACO Passavant AG Industrie Kleinzaun CH-8754 Netstal Tel. 055 / 645 53 00 E-Mail: aco@aco.ch		
zul. Abweichung: Norm		Oberfläche: DIN ISO 1302				
Erstellt:	Datum: 15.05.2019	Name: dca	Massstab: 1:10	Masseinheit: Millimeter	Projektion: ISO-E 	Diese Zeichnung darf weder kopiert noch dritten Personen, insbesondere zum Zweck anderweitiger Benutzung mitgeteilt werden und bleibt unser Eigentum. Copyright reserved! © ACO Passavant AG
Freigegeben:	14.11.2019	AB		Blatt / Anz.: 1 / 1		
Status:	Freigegeben			Zeichnung Nr.: CH 130827		
Bauelemente Revisionselement Monoblock S mit Gefälle Typ 8.1 Belaganschluss Art. Nr.: -				B 14.11.2019 AB Art. Nr.	A 11.10.2019 dca	