

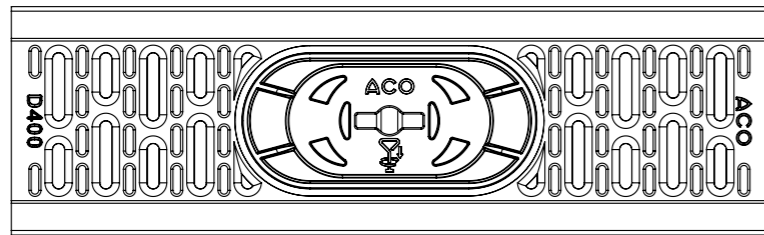

1:3

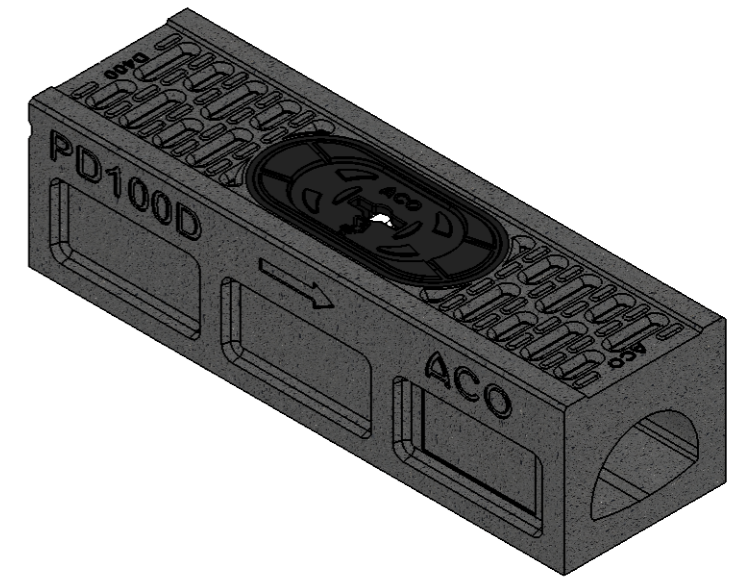
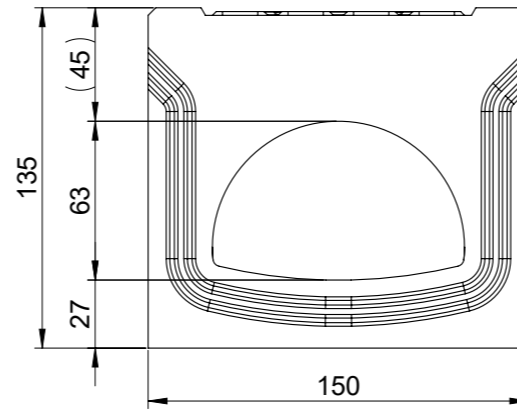
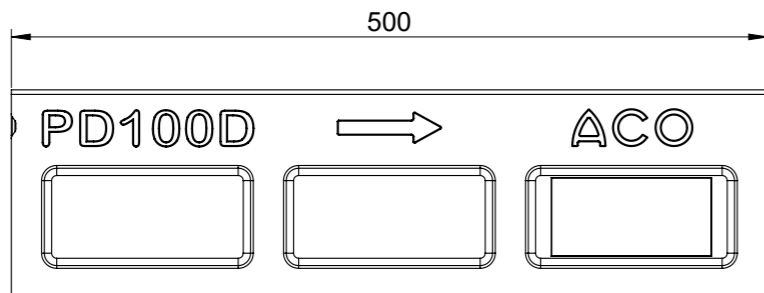
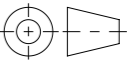

Werkstoff: Polymerbeton		Gewicht: 14.58 kg		 www.aco.ch	ACO AG Industrie Kleinzaun CH-8754 Netstal Tel. 055 / 645 53 00 E-Mail: aco@aco.ch		 Diese Zeichnung darf weder kopiert noch dritten Personen, insbesondere zum Zweck anderweitiger Benutzung mitgeteilt werden und bleibt unser Eigentum. Copyright reserved! © ACO AG	
zul. Abweichung: Norm		Oberfläche: DIN ISO 1302						
Erstellt:	Datum: 23.10.2025	Name: nae	Massstab: 1:5	Masseinheit: Millimeter	Projektion: ISO-E 	Zeichnung Nr.: CH 3052457		Index: -
Freigegeben:	30.10.2025	nae		Blatt / Anz.: 1 / 1				
Status:	Freigegeben			Erstausgabe				
Bauelemente Revisionselement PD100 senkr. Vorformung DN110 Art. Nr.: 3052457								